

**PACKAGE CONTENTS**

PART	DESCRIPTION	QUANTITY	
		P5188	P5197
A	Fixture	1	1
B	Cover	1	1
C	Cover Lock	4	4
D	Nipple (1/8IP)	5	4
E	Nipple (1/4IP)	0	1
F	Coupling	0	1
G	12" Pipe (1/8IP)	1	0
H	12" Pipe (1/4IP)	0	1

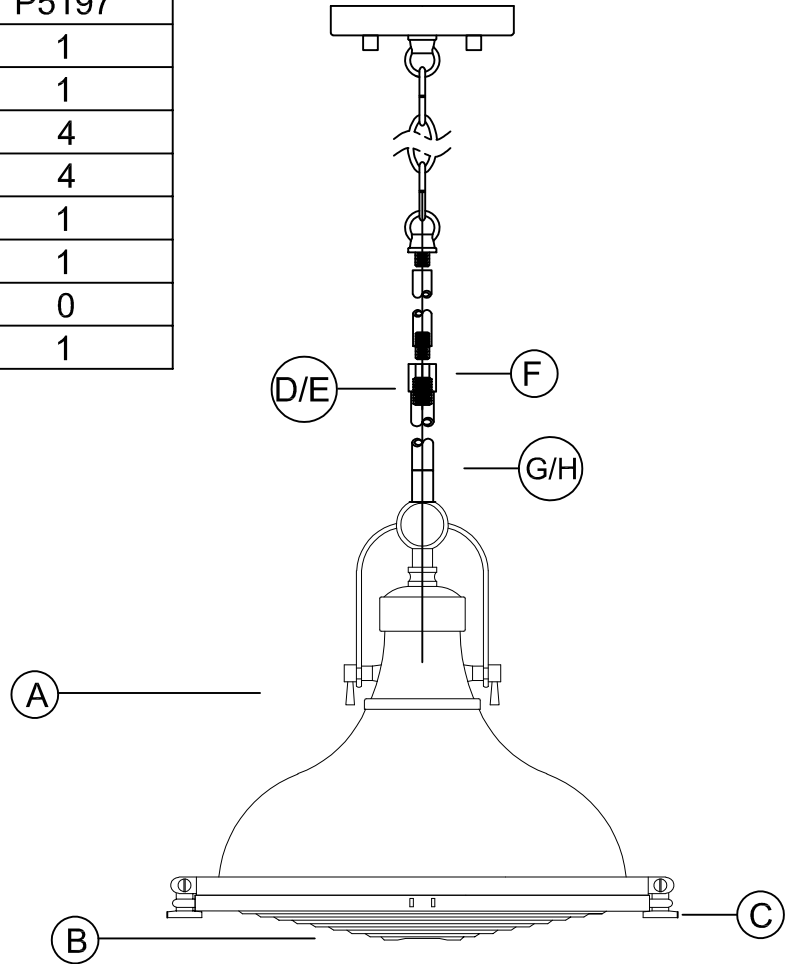

**HARDWARE CONTENTS (not actual size)**

AA	BB	CC	DD	EE	FF	GG	HH	JJ
Screw (#8-32) Qty:2	Wire nut Qty:3	Round Mounting Plate Qty:1	Hex nut (#8-32) Qty:2	Cylinder nut (#8-32) Qty:2	Chain (6 links) Qty:1	Chain loop (1/8IP) Qty:2	15" Pipe (1/8IP) Qty:2	6" Pipe (1/8IP) Qty:2



Missing parts? Please contact Customer Service at 1-800-447-0573, 8am-8pm (Eastern), Monday - Friday, or at [customerservice@progresslighting.com](mailto:customerservice@progresslighting.com)



## Safety Information

Please read and understand this entire manual before attempting to assemble, operate or install the product.

**CAUTION:** Read instructions carefully and turn electricity off at main circuit breaker panel before beginning installation.

**CAUTION:** Risk of fire. Min. 90°C supply conductors. Consult a qualified electrician to ensure correct branch circuit conductor.

**WARNING:** If any Special Control Devices are used with this fixture, follow instructions carefully to assure full compliance with N.E.C. requirements. If there are any questions, contact a qualified electrical contractor.

**CAUTION:** All glass is fragile. Use care when handling glass shades and bulbs.

## Preparation

1. Before beginning installation, make sure all parts are included using the contents diagrams from page 1. If any part is missing or damaged, do not attempt to assemble, install or operate the product.
2. Estimated assembly time: 30 minutes.
3. Tools required for assembly (not included): Phillips screwdriver, pliers, wire stripper, safety glasses, electrical tape, ladder.

## Care and Maintenance



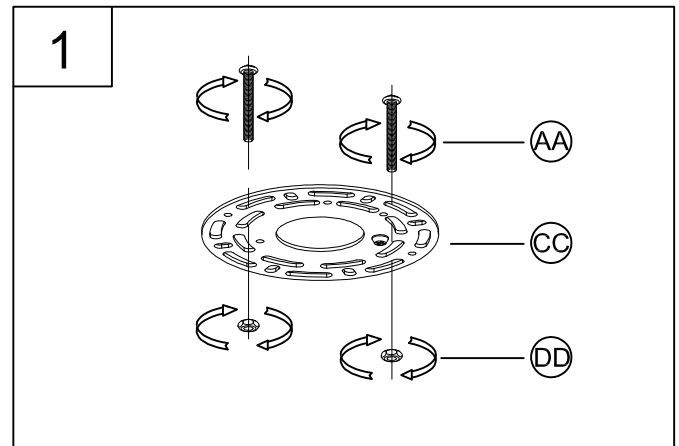

Shut off main power supply before cleaning product or changing light bulbs. To clean, wipe with damp cloth. Do not use abrasive cleaners or cleaners that contain alcohol.

## Assembly Instructions

1. Screw screw (AA) onto round mounting plate (CC) and use hex nut (DD) to secure it tightly.

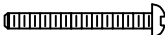

## Hardware Used



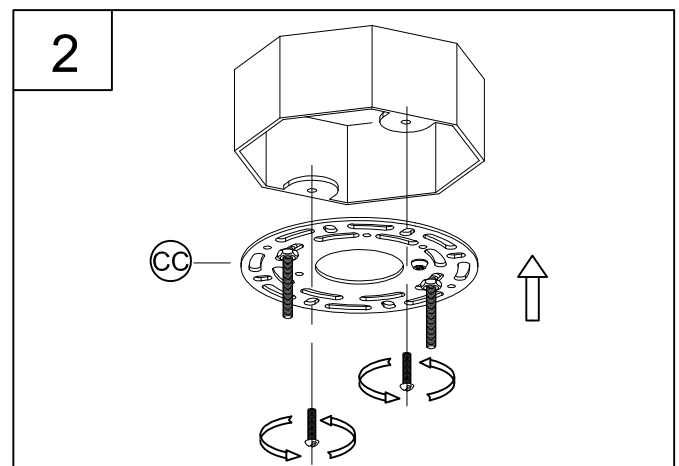

	Screw		X2
	Round mounting plate		X1
	Hex nut		X2

2. Attach assembled parts from step 1 onto junction box using the mounting screws supplied with the junction box (not included).

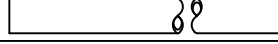
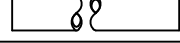

# Assembly Instructions

3. Pass the wires through the nipple (D/E)/two pipes (JJ)/ two pipes (HH) to achieve overall desired length. Next attach pipe onto fixture using nipple (D/E) and coupling (F) if needed. Secure tightly. Weave electric cord and ground wire through chain (FF) and chain loops (GG). Open two links of chain and attach both ends to chain loops (GG), close the chain links. NOTE: During this step, you may choose to shorten the chain and electrical/ground wires.

(FF) Chain		X1
(GG) Chain loop		X2
(HH) 15" Pipe		X2
(JJ) 6" Pipe		X2
(D/E) Nipple		X5
(F) Coupling		X1

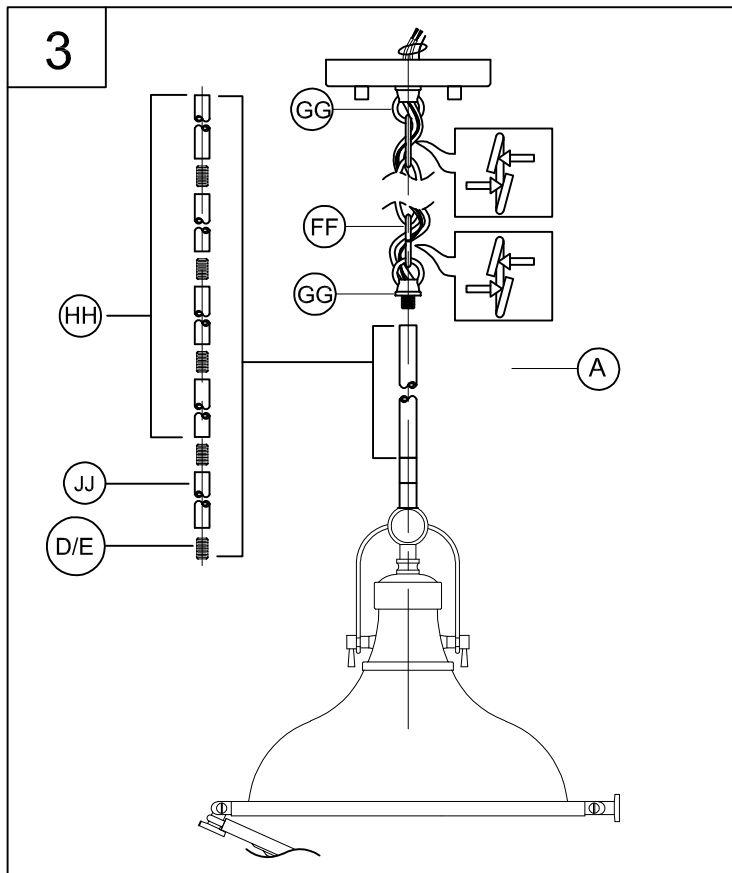

4. Strip 3/8" of insulation from the electrical wire ends. Using wire nuts (BB), connect RIBBED fixture wire to the WHITE supply wire from the junction box; connect the SMOOTH fixture wire to the BLACK supply wire. Connect the fixture ground wire and supply ground wire using a wire nut or by fastening to the ground screw on the round mounting plate. Push all wire connections into the outlet box.

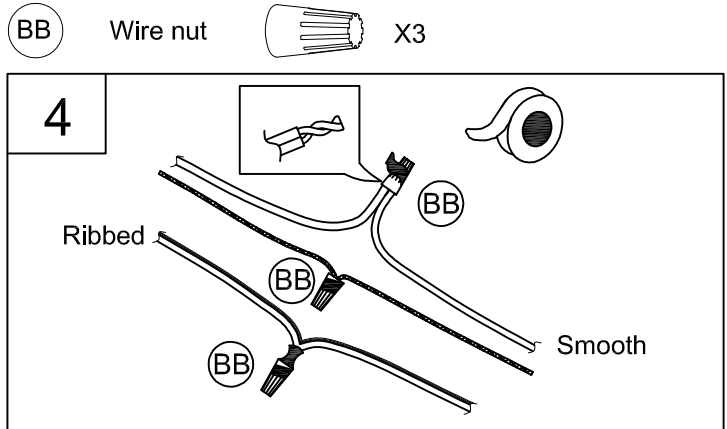

5. Secure the fixture (A) to screws (AA) using the two cylinder nuts (EE). Tighten securely.

(EE) Cylinder nut X2

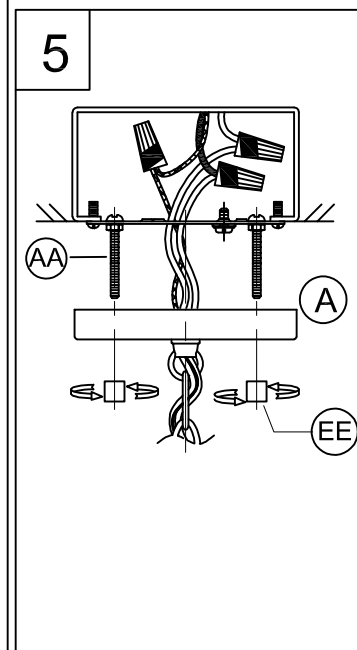

6. Screw lamp (not included) into fixture socket. Use 100-watt MAX incandescent medium base lamp, SBCFL or SBLED. Attach cover (B) to fixture (A) using cover locks (C) to secure tightly.

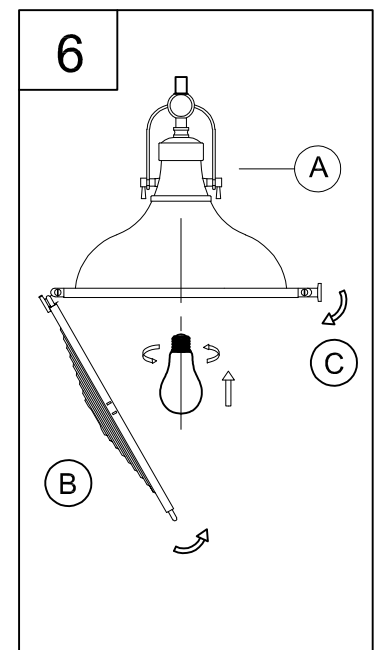

**WARRANTY AND EXCLUSIVE REMEDY:** Progress products, when properly installed and under normal conditions of use, are warranted to our customers only to be free from defects in material and workmanship at time of shipment. All warranty claims must be asserted within one year from date of purchase of the subject items; thereafter, warranty claims will not be honored. Customers' sole remedy for a warranty claim or otherwise shall be limited to repair or replacement of the subject product if it is shown to have been defective in material or workmanship at time of shipment. Progress' sole and maximum liability for a defective product shall never exceed the cost of the subject product. **EXCEPT FOR SUCH A WARRANTY AND EXCLUSIVE REMEDY AS STATED (AND THE EXPRESS WARRANTY OF TITLE), WE DISCLAIM ALL OTHER WARRANTIES, WHETHER EXPRESS OR IMPLIED, AND SPECIFICALLY DISCLAIM THE IMPLIED WARRANTIES OF MERCHANTABILITY AND FITNESS FOR A PARTICULAR PURPOSE. IN NO EVENT SHALL WE BE LIABLE TO CUSTOMER IN WARRANTY, CONTRACT, NEGLIGENCE, STRICT LIABILITY OR OTHERWISE, FOR ANY DAMAGES, WHETHER INCIDENTAL OR CONSEQUENTIAL, WHICH ARE ALLEGED TO BE CAUSED BY ONE OR MORE OF OUR PRODUCTS, BEYOND THE COST TO THE CUSTOMER OF THE SUBJECT PRODUCT OR PRODUCTS.** Therefore, the customer's sole and exclusive remedy against us for breach of the warranty, breach of contract or negligence or strict liability or otherwise shall be limited to repair or replacement of the subject product at our option (excluding installation and removal charges which shall not be our liability) or, if we choose, refund of the purchase price. In no case does our warranty and exclusive remedy extend to anybody other than our customers. Our customers are not authorized to extend warranties or remedies on our behalf to anyone. Such unauthorized extensions of warranties or remedies by the customer shall remain customer's responsibility. Customer is responsible for determining the suitability of our products for customer's use or resale, or for incorporating them into objects or for applications which customer designs, assembles, constructs or manufactures.

# Instrucciones de ensamblaje e instalación

Precaución: Lea cuidadosamente las instrucciones y desconecte la electricidad del cortacircuitos principal antes de iniciar la instalación.

**MISE EN GARDE:** Lire les instructions avec soin et couper le courant au disjoncteur central avant de commencer l'installation.

**MISE EN GARDE:** Risque d'incendie. Min 90°C conducteurs d'alimentation. Consulter un électricien qualifié pour assurer le bon conducteur de circuit de dérivation.

**AVERTISSEMENT** - S'il y a d'autres mécanismes régulateurs qui s'emploient avec ce dispositif, suivre soigneusement les instructions pour satisfaire aux exigences NEC. Si vous avez des questions, consulter un électricien qualifié.

**MISE EN GARDE** - Le verre est toujours fragile; maniez le(s) composant(s) et/ou l' (les) ampoule(s) avec prudence.

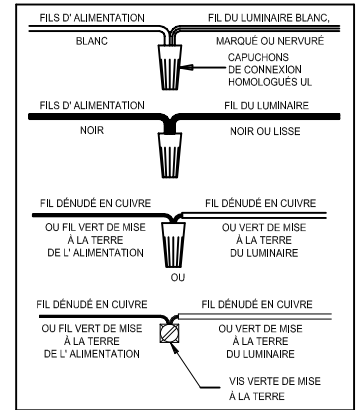

# Instructions d'Assemblage et Installation

Mise en garde: Lire les instructions avec soin et couper le courant au disjoncteur central avant de commencer l'installation.

**PRECAUCIÓN:** Lea cuidadosamente las instrucciones y desconecte la electricidad del cortacircuitos principal antes de iniciar la instalación.

**PRECAUCIÓN:** Riesgo de fuego. Min. 90°C los cables de suministro. Consulte a un electricista calificado para asegurarse de que el conductor del circuito derivado correcto.

**ADVERTENCIA** - Si usa algún dispositivo especial de control con este aparato de luz, siga las instrucciones cuidadosamente para asegurar la completa conformidad con los requisitos N.E.C. Si existe alguna duda, contacte un electricista calificado.

**PRECAUCION** - El vidrio es frágil; tenga cuidado al manipular el (los) elemento(s) de vidrio y/o la(s) bombilla(s).

